

The Airbus safety magazine

#27

# Safety first



**AIRBUS**

# Safety first

**Safety first, #27** January, 2019. Safety first is published by Airbus S.A.S. - 1, rond point Maurice Bellonte - 31707 Blagnac Cedex/France. Publisher and Editor: Yannick Malinge, Chief Product Safety Officer. Concept Design by Airbus Multi Media Support 20182972. Reference: X00D16031905 Issue 27. Photos by Airbus, H. Goussé, J.V. Reymondon, A. Doumenjou, P. Masclet, F. Lancelot, C. Koshorst. Cover by: J.V. Reymondon.

This brochure is printed on Stucco. This paper is produced in factories that are accredited EMAS and certified ISO 9001-14001, PEFC™ and FSC®CoC. It is produced using pulp that has been whitened without either chlorine or acid. The paper is entirely recyclable and is produced from trees grown in sustainable forest resources. The printing inks use organic pigments or minerals. There is no use of basic dyes or dangerous metals from the cadmium, lead, mercury or hexavalent chromium group.

## Editorial Team

**Guillaume  
ESTRAGNAT**



**Timothy  
ROACH**



**Daniel  
PERCY**



© Airbus S.A.S. 2018 – All rights reserved.  
Proprietary documents.

By taking delivery of this Brochure (hereafter "Brochure"), you accept on behalf of your company to comply with the following guidelines:

» No other intellectual property rights are granted by the delivery of this Brochure than the right to read it, for the sole purpose of information.

» This Brochure and its content shall not be modified and its illustrations and photos shall not be reproduced without prior written consent of Airbus.

» This Brochure and the materials it contains shall not, in whole or in part, be sold, rented, or licensed to any third party subject to payment.

This Brochure contains sensitive information that is correct at the time of going to press.

This information involves a number of factors that could change over time, effecting the true public representation. Airbus assumes no obligation to update any information contained in this document or with respect to the information described herein.

Airbus S.A.S. shall assume no liability for any damage in connection with the use of this Brochure and of the materials it contains, even if Airbus S.A.S. has been advised of the likelihood of such damages.

**The Airbus magazine contributing to the enhancement of the safety of aircraft operations by increasing knowledge and communication on safety related topics.**

Safety first is published by the Product Safety department. It is a source of specialist safety information for the use of airlines who fly and maintain Airbus aircraft. It is also distributed to other selected organizations and is available on digital devices.

Material for publication is obtained from multiple sources and includes selected information from the Airbus Flight Safety Confidential Reporting System, incident and accident investigation reports, system tests and flight tests. Material is also obtained from sources within the airline industry, studies and reports from government agencies and other aviation sources.

All articles in Safety first are presented for information only and are not intended to replace ICAO guidelines, standards or recommended practices, operator-mandated requirements or technical orders. The contents do not supersede any requirements mandated by the State of Registry of the Operator's aircraft or supersede or amend any Airbus type-specific AFM, AMM, FCOM, MMEL documentation or any other approved documentation.

Articles may be reprinted without permission, except where copyright source is indicated, but with acknowledgement to Airbus. Where Airbus is not the author, the contents of the article do not necessarily reflect the views of Airbus, neither do they indicate Company policy.

Contributions, comment and feedback are welcome. Enquiries related to this publication should be addressed to:

**Airbus**  
**Product Safety department (GS)**

1, rond point Maurice Bellonte  
31707 Blagnac Cedex - France  
Fax: +33(0)5 61 93 44 29

[safetycommunication@airbus.com](mailto:safetycommunication@airbus.com)

**Safety first app available here**



# editorial



**YANNICK MALINGE**  
SVP & Chief  
Product Safety Officer

---

Dear Aviation colleagues,

January is the period of the year at which we all take a look at the past year's safety record. In January 2018, in the Safety first issue 25 editorial, the first paragraph stated,

*"As we began the new year, commercial aviation safety was already making headlines. Fortunately, this was for the exceptionally low number of fatal accidents which occurred in 2017. It is a fantastic achievement and shows hugely encouraging progress. Yet as I am fond of saying, we must never be complacent".*

Unfortunately, in 2018 we have witnessed five fatal accidents of large commercial jet aircraft compared to only one in 2017.

This significant increase is the proof that we cannot afford to let a year with few accidents lead us into the trap of complacency.

We know that the flying public places their trust in us whenever they take a flight. With the number of flights increasing every year, we cannot stand still in our efforts to prevent accidents.

As industry professionals, we have to work together to ensure that we are maintaining and enhancing the level of safety.

Safety first magazine has long been one of the most public and tangible means by which Airbus demonstrates our commitment to safety, by sharing information on lessons learnt for the benefit of our operators.

So as I leave you to read through the magazine, let us remember the lesson of 2018; we must avoid the trap of complacency.

Best wishes to you all for this new year.

A handwritten signature in black ink, appearing to read 'Y Malinge', with a long horizontal line extending to the right.

# Safety First

also available in app  
and website versions



Visit us at <http://safetyfirst.airbus.com/>

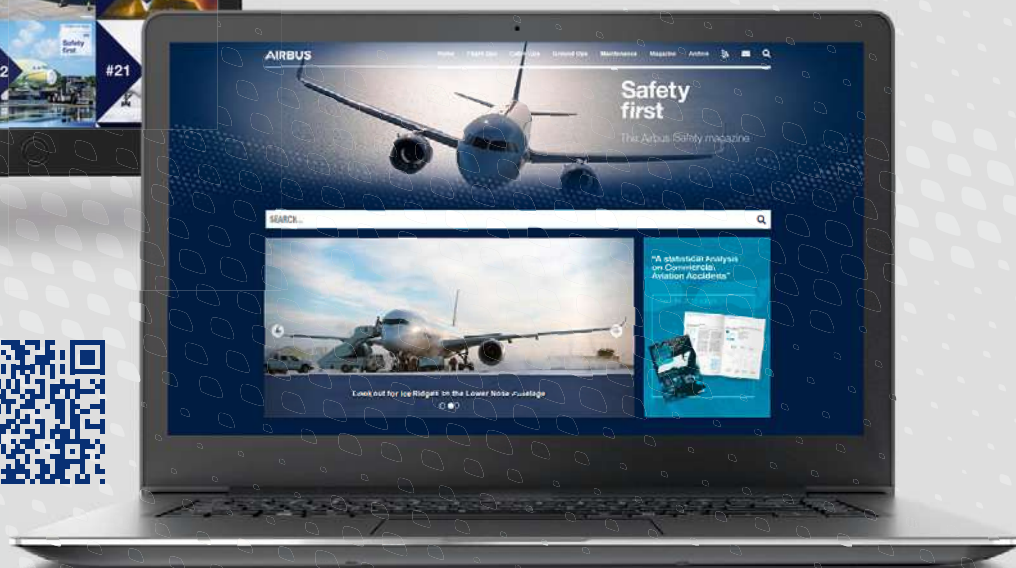



**Airbus' annual flight safety conference is the forum for airbus and our customers to share safety lessons learnt and best practices.**

It also provides a venue to establish networking opportunities between airline Safety Officers and Management Pilots in addition to interacting with Airbus Safety, Flight Test, Flight Ops, and Chief Engineering personnel.

**SAFETY THEMES IN 2019:**

- **Reflecting on the last 25 years of flight safety**
- **Looking ahead toward strategies & training evolution for the next 25 years**

This 25th edition provides the opportunity for Airbus and its customers to reflect on the evolution of Air Transport Safety since our 1st Flight Safety Conference 25 years ago, and exchange on how we can further enhance the safety for our industry as we fly into the next 25 years.

With illustrative examples given by Airlines, plus Accident Investigator Briefings and demonstration sessions for PREVENT, an automated assistant for flight safety management.

**ATTENDANCE & INVITATIONS**

The 25th Airbus Flight Safety Conference will be held in Athens, Greece from 25-28 March 2019. Invitations were sent to our customer airlines and operators in January.





# Safety first #27

## PROCEDURES

P06 

Engine Thrust Management -  
Thrust Setting at Takeoff

---

## AIRCRAFT

P16    

Preventing Inadvertent Slide  
Deployments

---

## OPERATIONS

P24    

Preventing Violent Door Opening  
due to Residual Cabin Pressure

---

P32 

Lessons Learned About  
the Teach-In Function

 Flight operations

 Cabin Operations

 Ground Operations

 Maintenance



# Engine Thrust Management - Thrust Setting at Takeoff

The FCOM Standard Operating Procedures (SOP) provide specific guidance to flight crews for thrust application at takeoff.

This article explains why 2-step thrust application is required at takeoff and why some extra steps should be taken in tailwind or significant crosswind conditions. It also provides recommendations to ensure optimum lateral control of the aircraft during takeoff roll and how to react if an asymmetric event is experienced at low speed.



## ANALYSIS OF AN EVENT

### Event Description

An A320 equipped with IAE engines was lined up for a static takeoff using Flex Thrust. It was 10:40pm local time, the runway was dry, the wind negligible and the outside air temperature had reached 33°C. There was a slight difference in the position of left and right thrust levers when the aircraft lined up on the runway that resulted in the following Engine Pressure Ratios (EPR) and N2 values:

- ENG 1: 1.01 EPR      61% N2
- ENG 2: 1.03 EPR      75% N2

The Pilot Flying (PF) then moved both thrust levers forward and paused for around 3 seconds near to the CLB detent where, the EPR and N2 increased to the the following values:

- ENG 1: 1.03 EPR      78% N2
- ENG 2: 1.24 EPR      91% N2

Eventually, the PF released the brakes and moved the thrust levers forward to the FLX detent. Engine 2 accelerated more rapidly than engine 1 and the resulting thrust asymmetry caused the aircraft to veer to the left. The PF tried to recover the trajectory by applying right rudder input and retarding the thrust levers to reduce thrust on both engines. Consequently, this caused the aircraft to sharply veer to the right. The PF applied differential thrust combined with left rudder pedals and tiller inputs. This caused the aircraft to veer sharply to its left while continuing to accelerate. The PF reacted again to apply full right rudder input combined with asymmetric braking and applied maximum thrust reversers in an attempt to stop the aircraft. The aircraft eventually came to rest to the left of the runway at 300 meters from the threshold (**fig. 1**). During this event, the ground speed did not exceed 31 kt.

### Event Analysis

The root cause of this event was the initial difficulty to control the aircraft laterally due to the rapid asymmetric thrust increase at low speed. We will analyse this phenomenon in the following paragraphs and explain how the pilots can ensure a symmetric thrust increases to ease the lateral control of the aircraft in the early takeoff roll.

**(fig.1)**

View from above of the aircraft trajectory

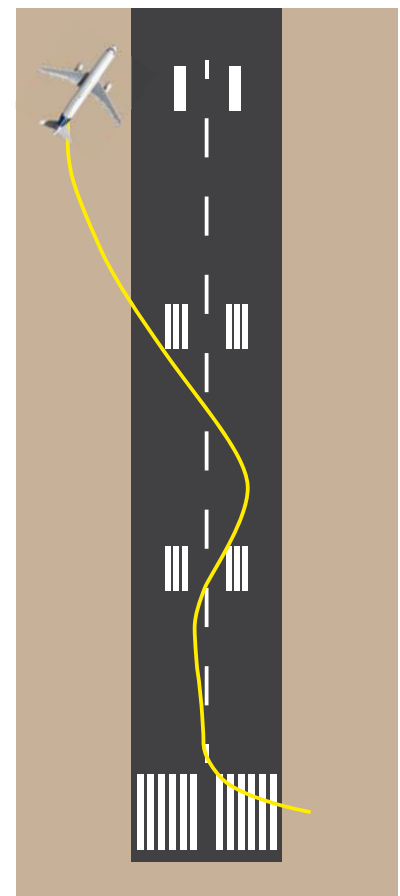

# PROCEDURES

“ The acceleration profiles may slightly differ from one engine to another on an aircraft, even if fitted with new engines. ”

## Why could aircraft engines accelerate asymmetrically at takeoff?

On all jet engines, but particularly on high bypass ratio engines, the engine acceleration profile is not linear (**fig.2**). It follows the engine control law that is defined to optimize the acceleration in a way that the risk of engine stall is reduced. It also takes into account the influence of the position of the engine installed on the aircraft and the effect on the airflow at the engine's inlet due to its proximity to the ground and the surrounding aircraft structure.

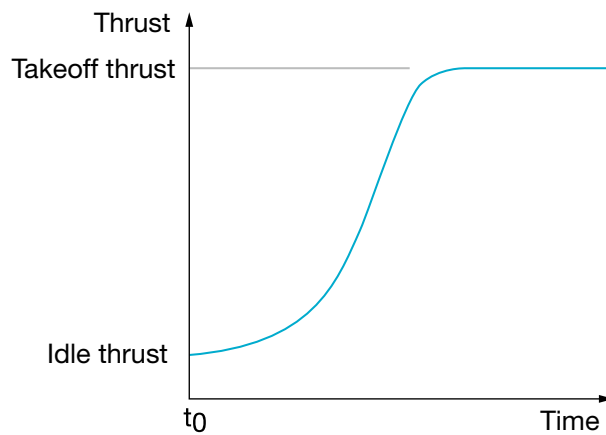

**(fig.2)**  
Typical engine acceleration profile.

Every engine has its own performance level due to manufacturing tolerances. In addition, engine performance evolves with time due to wear and ageing. As a consequence, the acceleration profiles may slightly differ from one engine to another on an aircraft (**fig.3**), even if fitted with new engines.

Similarly, the idle thrust can slightly differ from one engine to the other, moving the acceleration profile to the left on the graph (**fig.4**).

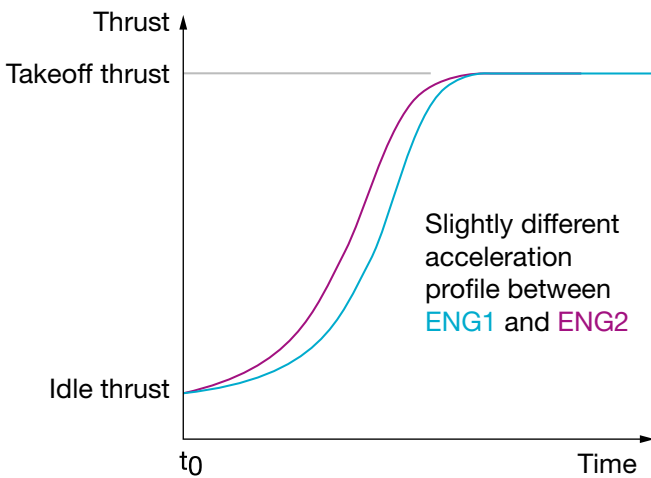

**(fig.3)**  
Difference between engines' acceleration profile.

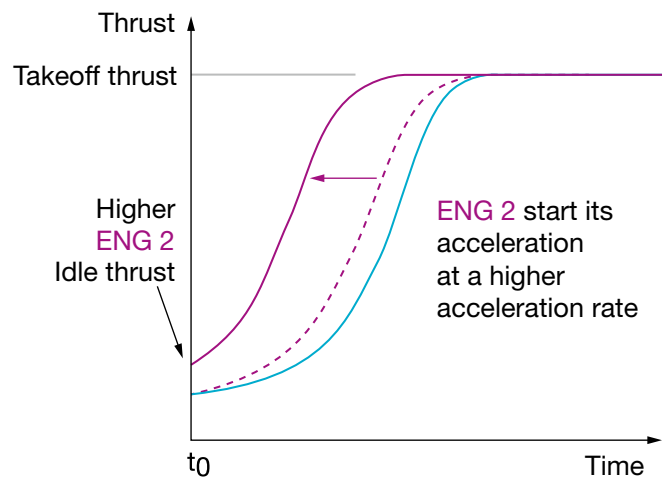

**(fig.4)**  
Difference between engines' idle thrust.

Taking into consideration both of these parameters, if the flight crew applies the takeoff thrust directly from idle thrust, without doing any stabilization step, the difference in engine acceleration performance could cause a strong asymmetric thrust condition **(fig.5)** that could be difficult to counteract with nose wheel steering only, due to limited effectivity of the rudder at low speed. ■

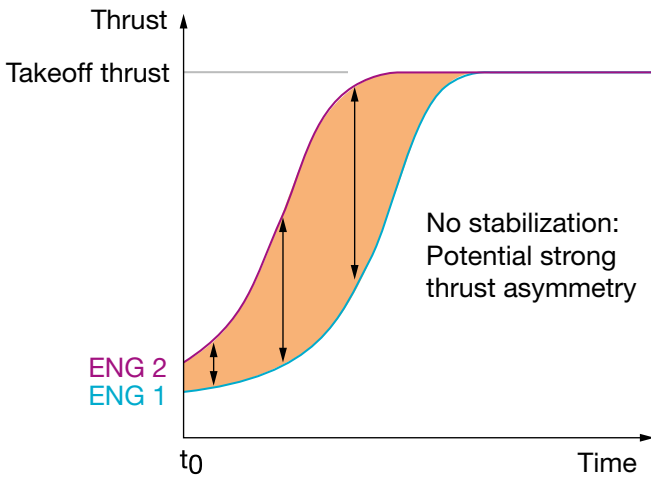

**(fig.5)**  
Direct takeoff thrust application with no thrust stabilization step potentially creates a strong thrust asymmetry that may be difficult to counteract.

## ENSURING A SYMMETRIC THRUST INCREASE AT TAKEOFF

### FCOM Standard Operating Procedure

To avoid this potential strong thrust asymmetry, the FCOM SOP for takeoff provides a procedure that requests pilots to apply takeoff thrust in two distinct steps **(fig.6)** with some additional guidance for certain aircraft operating in the case of tailwind or significant crosswind conditions.

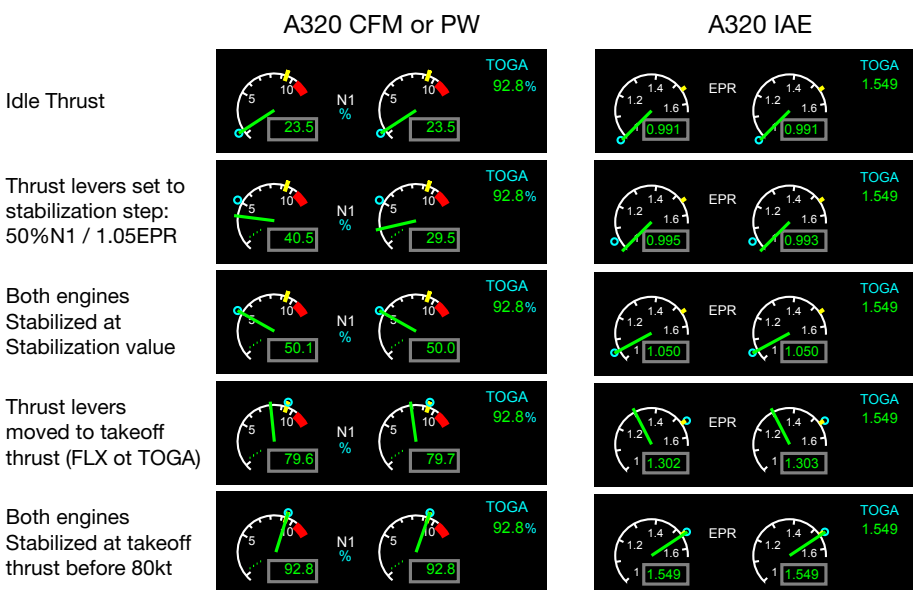

**(fig.6)**  
Example of the standard thrust setting procedure at takeoff for an A320 aircraft depending on the engine type.

## PROCEDURES

### Engine Thrust Management - Thrust Setting at Takeoff

“ The stabilization step ensures that all engines reach a rotation speed value from where the increase of engine thrust will be almost identical to each other. ”

#### (fig.7)

Using a stabilization step, the potential thrust asymmetry remains limited before the stabilization and both engines accelerate almost simultaneously from  $t_s$ .

### Why pilots should set thrust in two steps for takeoff?

The stabilization step ensures that all engines reach a rotation speed value from where the increase of engine thrust will be almost identical to each other (fig.7). The N1/EPR/THR stabilization value is defined during flight test campaign for every engine type with collaboration from engine manufacturers.

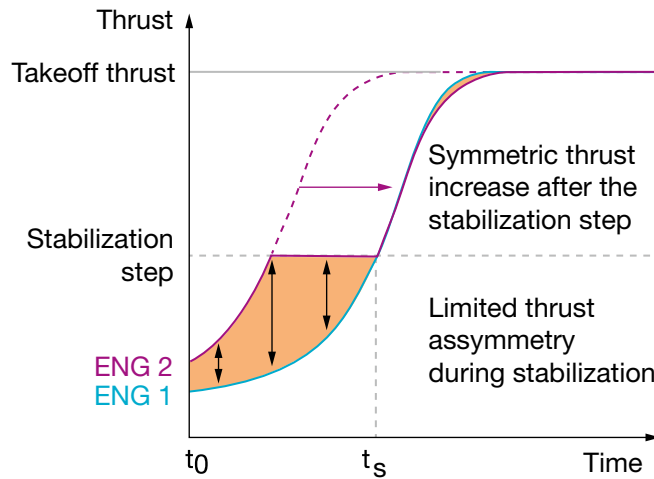

### Specific use-case when differential thrust is used for the aircraft line-up

In some cases, differential thrust is used to line-up the aircraft on the runway. If the pilot commands takeoff power without first doing the engine thrust stabilization step, the resulting asymmetric thrust condition may be significant due the engines accelerating from an already very different rotation speed.

This is why a thrust stabilization step is important after using differential thrust to line-up the aircraft, to avoid causing a strong thrust asymmetry condition during the early stages of the takeoff roll.

### Static takeoff or rolling takeoff?

The FCOM describes procedures for a static takeoff, but a rolling takeoff is also permitted.

During static takeoff, the brakes are released at  $t_s$  (fig.7) once all engines have reached the stabilization step value, therefore, the aircraft is not affected by any potential thrust asymmetry that can happen between  $t_0$  and  $t_s$ .

If a rolling takeoff is performed, the pilot must also respect the stabilization step. The flight crew uses opposite rudder pedals inputs as the aircraft is rolling to counteract any thrust asymmetry experienced during the stabilization phase between  $t_0$  and  $t_s$ . With the engines at a low rotation speed the potential thrust asymmetry remains limited up to the engine stabilization step value.

## Why an additional thrust setting is necessary in tailwind or significant crosswind conditions?

In tailwind and significant crosswind conditions, the airflow entering into the engines is modified (**fig.8**). Some perturbations may appear downstream of the leading edge of the engine inlet and potentially cause an engine stall if the perturbed airflow enters the core of the engine.

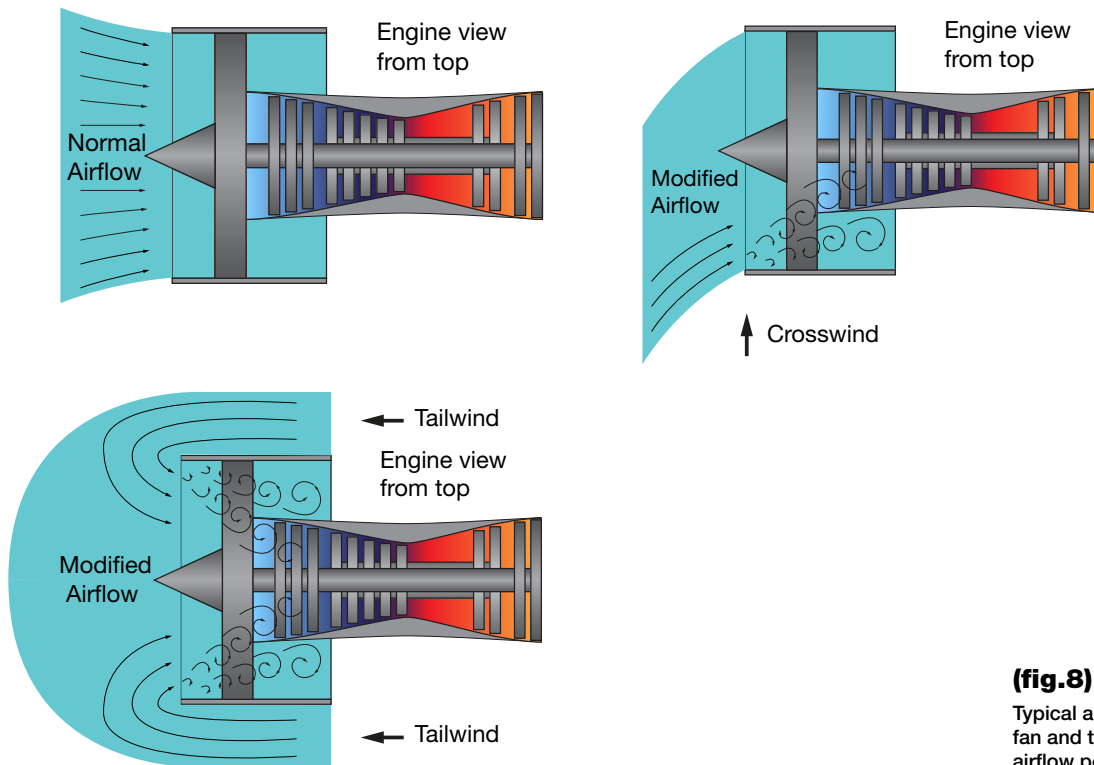

**(fig.8)**

Typical airflow distortion affecting the fan and the engine core with associated airflow perturbations.

The FCOM thrust setting procedure in the case of tailwind or significant crosswind is in two steps:

- Step one is to ensure engines increase their thrust symmetrically by using the stabilization step.
- Step two is acceleration of the aircraft with the pilot progressively increasing thrust from the stabilization step value to reach takeoff thrust. As the aircraft accelerates the relative wind resulting from the forward momentum counters the disturbed airflow conditions caused by crosswind or tailwind, reducing the risk of engine stall and the risk of experiencing the associated thrust asymmetry.



## NOTE

For A330 and A380 equipped with Rolls Royce TRENT engines, the FCOM procedure does not request the pilot to apply progressive thrust application between the engine stabilization step and the takeoff thrust in case of tailwind or significant crosswind. The engine control logic automatically manages the engine thrust during the takeoff roll on these aircraft.

### Specificity of aircraft equipped with Rolls Royce and IAE engines

On aircraft equipped with Rolls Royce or IAE engines, a “keep-out zone” prevents stabilized engine operation in a specific N1/EPR range, when on ground below a certain speed, to prevent fan instability. During the progressive application of the takeoff thrust after the stabilization step, the flight crew should ensure that the levers are advanced **continuously and simultaneously**. Moving the thrust levers too slowly may lead to asymmetric engine acceleration if one thrust lever is moved outside of the keep-out zone before the other.

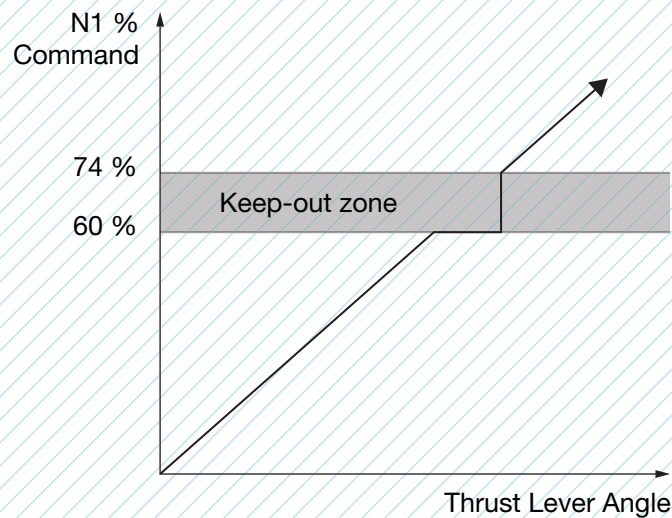

**(fig.9)**

Example of the keep-out zone on A320 aircraft equipped with IAE engines

### What if asymmetric thrust happens at low speed during the takeoff roll?

In the case of an asymmetric thrust event at takeoff, the flight crew should reject the takeoff if the veering moment cannot be counteracted using nose wheel steering.

The technique described in the FCTM “engine failure at low speed” should be applied:

- Immediately reduce all thrust levers to IDLE
- Select all reversers
- Use rudder pedals for directional control, supplemented by symmetrical or differential braking if needed

## Communication between Pilot Flying and Pilot Monitoring

During the takeoff roll, a key role of the Pilot Monitoring (PM) is to monitor engine thrust. The PM must monitor the N1/EPR below 80kt, and announce “THRUST SET” when the takeoff thrust is reached for all engines. Should any thrust asymmetry be observed, the PM must immediately inform the PF and may call for a rejected takeoff if needed. ■

## ADDITIONAL RECOMMENDATIONS TO FLIGHT CREWS

---

The event described at the beginning of this article is also the opportunity to remind flight crews with some recommendations to facilitate the lateral control of the aircraft .

### Forward sidestick input during the early stage of the takeoff roll

(Except on A380) - The FCOM also requests pilots apply a half-forward side stick input, or full forward input if there is tailwind or significant crosswind, up to 80kt IAS to counter the nose up effect of the thrust application and then release this input gradually to reach the side stick neutral position at 100kt. This will increase the load on the nose wheel to aid in directional control of the aircraft.

### Seating position and pedals adjustment

Since the flight crew can only rely on the nose wheel steering and to the last extend differential braking to maintain the centerline during the low speed part of the takeoff roll, they must make sure that they are properly seated. The pilot should be able to move the rudder pedals to their maximum deflection and apply maximum manual braking at the same time, should a rejected takeoff be initiated.

An incorrect pedal adjustment can make it difficult for the pilot to apply differential braking when needed. It can even lead to an opposite differential braking if the pedals are too far from the pilot.

Refer to the FCTM and to the [“Are you properly seated?”](#) Safety first article published in January 2018 for more information on adjustments to achieve optimal pilot’s seating position. ■

# PROCEDURES

## Engine Thrust Management - Thrust Setting at Takeoff

### CONTRIBUTORS:

#### **Norbert HIRTZ**

Powerplant Expert  
Design Office

#### **Xavier BOUSQUET**

Head of Engine Performance  
Design Office

#### **Capt. Xavier LESCEU**

HO Operational & Training Policy  
Flight Operations Support

#### **Sourya KAHLOUL**

Flight Operations  
Support Engineer  
Flight Operations Support  
and Training Policy

#### **Sundeep GUPTA**

Accident Investigator  
Product Safety

### With thanks to:

**Xavier VILLAIN,  
Olivier LAFFONT,  
Marc LE-LOUER**  
from the Flight  
Operations Support

To ensure that an aircraft's engines simultaneously accelerate during the early stages of the takeoff roll, the flight crews must wait for all engines to reach the stabilization step before advancing the thrust levers to command takeoff thrust. If the pilot flying applies takeoff thrust directly from idle without observing the stabilization step, the engines may accelerate at different rates and this will cause an asymmetric thrust condition, which may be difficult to counteract and could lead to a lateral runway excursion event.

In the case of tailwind or significant crosswind, the progressive increase of engine thrust from the stabilization step up to takeoff will allow the gradual acceleration of the aircraft to counter the effects of the distorted airflow at the engine's inlet and avoid the airflow disturbances inside the engine that may cause an engine to stall.

If an asymmetrical thrust condition is experienced at a low speed during the takeoff roll, and the flight crew cannot counteract it through rudder pedals inputs, the takeoff must be rejected using all thrust reversers and by applying differential braking if needed to bring the aircraft to a safe stop.







# Preventing Inadvertent Slide Deployments

The number of people injured when emergency escape slides are inadvertently deployed is low. Nevertheless, such events pose a threat to the safety of people in or around aircraft. They are also a cause of aircraft damage, and departure delays.

This article looks at how Inadvertent Slide Deployments (ISDs) can be avoided, and presents a new solution available to prevent them.

# INADVERTENT SLIDE DEPLOYMENTS

## ISDs and their impact

Aircraft escape slides are an essential piece of Safety equipment. Designed to be fully deployed and inflated within a maximum of ten seconds, they are a powerful and efficient means of ensuring safe exit from an aircraft in case of an emergency.

Yet the same speed and efficiency of activation can also mean that there is no time to stop the deployment, when anybody operating a door inadvertently activates a slide.

As per IATA definitions, an Inadvertent Slide Deployment (ISD) is the 'unintentional deployment (full or partial) of an aircraft emergency evacuation slide or slide raft'.

ISDs occur when the operator attempts to open the door under normal operational circumstances such as at aircraft turnaround, when the slide is in the armed condition.

If an ISD occurs, it may cause serious injury of operatives inside the cabin or outside the aircraft. ISDs also have economic impacts and cause operational disruptions.

The minimum cost of an event involving a 90 minute ground delay is estimated at around 11,000 USD. If the ISD leads to a flight cancellation and a requirement to accommodate passengers in hotels, the cost can rise as high as 200,000 USD.

## Causes of ISDs

Airbus monitors reports of ISDs coming in from in-service operations, and investigates each report to understand the causes. The number of cases reported to Airbus is quite consistent on an annual basis, at 35-45 per year.

Investigation of the location of ISDs occurring on Airbus fleets in 2017 shows that the majority occur at the forward left door and the rear doors, due to the more frequent usage for boarding and loading operations.

“ An Inadvertent Slide Deployment is the full or partial unintentional deployment of an aircraft emergency evacuation slide or slide raft. ”

### (fig.1)

Results of a study into factors contributing to ISDs.  
Source: IATA Cabin Operations Safety Conference 2014.

An IATA survey of 47 airlines conducted between 2014 & 2015, found that the occupational group most frequently identified in reported ISDs was cabin crew. Ground staff, maintenance, flight crew and passengers were all less frequently identified in ISD reports.

### Factors contributing to ISDs

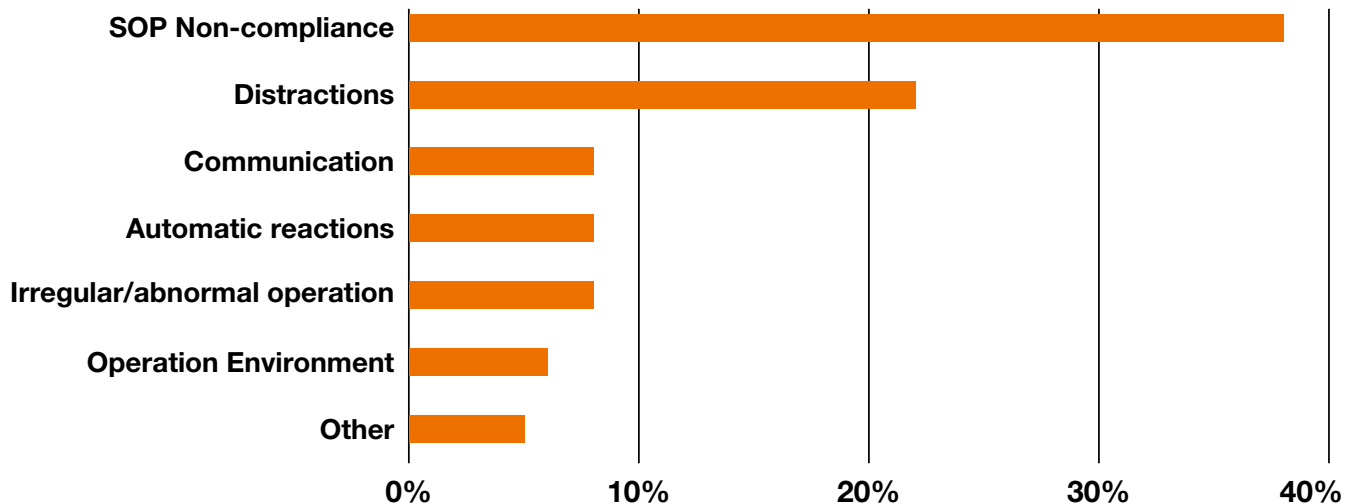

“ SOP Non-compliance and distractions are identified as the leading factors of ISDs. ”

In a previous study presented at the 2017 IATA Cabin Operations Safety Conference, a number of contributing factors to ISDs were identified which are highlighted in **(fig.1)**. SOP Non-compliance and distractions are identified as the leading factors.

In reports provided to Airbus these factors are also evident, together with information putting into context the human factors elements associated with the report.

Issues of crew fatigue, distraction by passengers moving in the cabin, and the time pressures of turn-around operations can be identified.

Other factors include poor communication/coordination between crew members, and the complexity present when cabin crew fly on various aircraft types with different door designs. ■

### Examples of ISD report contents:

*“The captain accidentally deployed Door 1R slide at the gate, when he opened the door to look outside, the door was still armed.”*

*“At arrival, the flight attendant at the forward doors inadvertently pulled the door operating handle instead of the door disarming lever.”*

*“During a short transit time, catering staff opened Door 1R in armed position and the escape slide deployed.”*

# DOOR OPENING PRACTICES

## Cabin Crew Standard Operating Procedures (SOP)

Definition of SOP by each airline is a process which needs to take into account factors specific to the airline, including standardisation of procedures in mixed fleet operations between aircraft of different manufacturers, the regulations of local airworthiness authorities, practices of ground handling companies at different airports, etc.

It is therefore an airline responsibility to identify within their own SOP which staff take which actions, and when. Nevertheless, in all cases, the procedures to arm and disarm the slide include three stages; the command, the action (arm or disarm), and the confirmation (cross-check).

When performing these three stages on Airbus aircraft, SOP can take into account the design of Airbus slides, which include a Safety Pin. When used in accordance with SOP, the Safety Pins prevent the arming lever from being inadvertently moved to the armed position.

## The Airbus PIN-LEVER-PIN model

Once the command to arm or disarm the slides has been issued, cabin crew can use the mental model of 'PIN-LEVER-PIN' in order to ensure the steps associated with arming or disarming in the SOP are correctly followed.



**(fig.2)**

ARMED/DISARMED conditions for A320 Family cabin door

- A** Visual indicator shows **ARMED** condition
- B** Arming lever in the **ARMED** position
- C** Safety pin in its stowage
- D** Safety pin installed
- E** Visual indicator shows **DISARMED** condition
- F** Arming lever in the **DISARMED** position

To disarm a door slide, the first action is to remove the safety pin from its stowage in the door (PIN). The arming lever is then placed in the disarmed position (LEVER). Finally, the Safety Pin is inserted into the dedicated hole near the Arming Lever (PIN). The lever then cannot be accidentally being moved from the disarmed to the armed position.

**(fig.3)**

Girt Bar Floor Indicator on A320 Family aircraft



To arm a slide, the procedure is applied in reverse; the Safety Pin is removed from its hole near the Arming Lever (PIN). The Arming Lever can then be pushed down into the armed position (LEVER). With the door armed, the pin is placed back in its stowage (PIN).

Once the arm or disarm action is complete, the principle means of confirmation of the door condition of the door is by use of the Visual Indicator **(fig.2)**.

For A320 Family aircraft, Girt Bar Floor indicators at doors 1 and 4 provide an additional visual indicator to aid crew awareness of the slide's arming condition **(fig.3)**. When the door is armed the indicator (orange spot) aligns with an arrow. ■

## A PRODUCT IMPROVEMENT TO PREVENT ISD

Doors on Airbus aircraft are equipped with a "SLIDE ARMED" warning light and an optional buzzer. This light and buzzer are activated when the slide is armed and someone lifts the door handle.

In order to prevent ISDs Airbus has introduced an upgraded "SLIDE ARMED" light and buzzer system, which provides a warning to operatives before they touch the handle.

This system is called the Inadvertent Slide Deployment Prevention Light (ISDPL), and is currently available for the forward and aft doors of A320 Family aircraft.

### Inadvertent Slide Deployment Prevention Light (ISDPL)

ISDPL is a maintenance free plug & play replacement to the standard Slide Armed Warning Lights, which are installed under the passenger door window **(fig.4)**.

Compared to the standard warning light, ISDPL also includes an ultrasonic sensor to measure the proximity of personnel to the door handle, and a small loudspeaker to provide audible warnings.

**(fig.4)**

Example of pre and post-modification ISDPL



Standard Slide Armed Warning Light



ISDPL

When operative, ISDPL provides both visual and audible means for reminding personnel who are operating the door that the door is armed. Both visual and acoustic alerts are triggered when three conditions are met:

1. The aircraft is powered, and on ground
2. The slide lever is in the armed position
3. A person approaches or tries to lift the door handle

As operatives approach the door, warnings are triggered. Two different warning levels occur, depending on the person's proximity to the ultrasonic detection device, located near the door handle **(fig.5)**.

When someone approaches within 50 cm of the ultrasonic detection device, the slide armed warning light flashes.

When someone approaches within 30 cm of the ultrasonic detection device, a second level of warning is generated by adding three short audio warnings in addition to the flashing light.

As with the basic "SLIDE ARMED" warning light, when someone has placed their hand in immediate proximity to the ultrasonic detection device, or moves the handle, ISDPL makes a continuous noise and the light remains on.

## Testing & Certification

The development of ISDPL has been driven primarily by Human Factors (HF) considerations. Specifically, the design objective has been to provide a warning that reminds operatives that the slide is armed, with the warning being provided early enough to prevent crew action.

Testing of different designs allowed Airbus to identify that this warning must be provided before operatives have touched the handle.

Full scale Human Factors tests using the visual plus audible warning concept embodied in ISDPL were conducted with 240 industry professionals from three airlines including 185 cabin crew and 23 flight crew. These tests successfully validated that the concept prevents operatives from opening the door when the slide is still armed.

During certification of the design with the airworthiness authorities, additional Human Factors tests were performed to prove that passengers would still open the door during a real evacuation.

These tests proved that, when under evacuation conditions, the visual and audible warnings do not delay or prevent actions to open the door and deploy the escape slides.

## Availability

ISDPL is available for both line-fit and retrofit on a chargeable basis, for A320 Family aircraft. Offerability of ISDPL on other Airbus programmes is currently under review. ■

**(fig.5)**

The levels of warning generated by ISDPL depend on proximity to the detection sensor

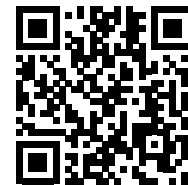
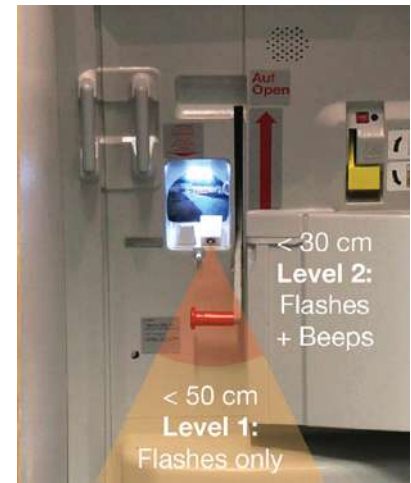

Watch a description video of the ISDPL by scanning this QR code, or connect to [safetyfirst.airbus.com](https://safetyfirst.airbus.com)

## ISD ON A321 DOORS 2 & 3

Whilst over 70% of ISDs reported to Airbus occur at Doors 1 or 4 due to action by cabin crew or pilots, a further 25% of reported cases occur on Doors 2 and 3 of A321 aircraft.

Emergency Exit Doors are installed on all A321 aircraft, except on A321neo models with Airbus Cabin Flex (ACF). On A321neo ACF aircraft, Door 3 remains an Emergency Exit door which may however be optionally deactivated.

A321 Emergency Exit doors are similar in appearance to normal passenger doors, except that the escape slides are installed in the fuselage and not a door bustle.

Since they are emergency exits the majority of airlines do not configure them for passenger boarding/disembarkation. ISD reports to Airbus indicate that the slides of these doors are often left in the armed condition during turnaround. ISDs subsequently occur when the doors are opened by maintenance, or other operatives onboard the aircraft.

For cabin crew, Airbus SOPs for arming/disarming of the slides on these doors are the same as for Doors 1 and 4, and available in the CCOM Departure/Arrival procedures.

For maintenance staff, the procedures for slide arming or disarming of A321ceo Door 2 and 3 can be found in the AMM in chapter 52-22. Operators can communicate these procedures to any subcontracting organization which will need to open the doors, including catering or cleaning suppliers. ■

### AMM Procedures for opening A321ceo emergency exit doors

Opening of the Emergency Exit Doors from the Inside TASK 52-22-00-010-001-A

Opening of the Emergency Exit Doors from the Outside TASK 52-22-00-010-002-A

#### (fig.6)

Example of an A321ceo Emergency Exit Door, installed at Doors 2 and 3. Reports to Airbus indicate that 25% of ISDs on Airbus fleets occur on these doors. Reports indicate that the slides of these doors are sometimes left in the armed condition during turnaround.





**CONTRIBUTORS:****Dr. Hans-Gerhard GIESA**

Senior Expert  
Human Factors Engineering

**Valerie RENAULDON**

Cabin operations Safety Expert  
Human factors

**Kai BREDEMEIER**

Component Architect  
Engineering

**Jean-Paul VIEU**

Flight Operations Engineer  
Flight Operations Support

**Ioanna KOURANTI**

Operations Safety Advisor  
Customer Engineering Support

**Mohammed ALAHYANE**

Product Leader  
Emergency Equipment  
Customer Engineering Support

Inadvertent Slide Deployments (ISDs) can occur, and may cause serious injury of operatives inside the cabin or outside the aircraft. ISDs also have economic impacts and cause operational disruptions.

The main causes of ISDs are non-compliance with Standard Operating Procedures (SOPs), and operatives being distracted whilst operating the doors.

Human factors considerations such as crew fatigue and time pressures during turn-around operations are a key aspect behind non-compliance to SOPs.

To assist crew in memorising the correct sequence of actions in arming or disarming a slide, Airbus recommends using the mental model 'PIN-LEVER-PIN'.

To address the human factor considerations through a technical solution, a product improvement called Inadvertent Slide Deployment Prevention Light (ISDPL), is now available for the forward and aft doors of A320 Family aircraft.



# Preventing Violent Door Opening due to Residual Cabin Pressure

Thousands of aircraft doors are opened daily, usually without incident. However, several events are reported to Airbus each year where residual cabin pressure caused a door to open violently, leading to serious injuries or aircraft damage.

This article describes the available residual cabin pressure warnings, with their limitations. It recalls the recommendations for flight crew, cabin crew, and ground staff to take before opening an aircraft door and provides the safety precautions to take to avoid unintentional pressurization of the aircraft on ground.



This article supersedes the “Residual Cabin Pressure” article published in the Safety first issue #3.

After landing, the cabin pressure equalizes with the external air pressure when the outflow valves are fully open (fig.1). There is one outflow valve on the A320 family, two on A300/A300-600/A310/A330/A340 and A350 aircraft, and four on A380 aircraft.

In some abnormal cases, outflow valves can remain closed, when the aircraft is on the ground, causing the air pressure in the cabin to be higher than the ambient air pressure outside the aircraft. In this case, there is a risk that an aircraft door could violently open and injure the operator or damage the aircraft.

**(fig.1)**  
Normal and abnormal configuration of the outflow valves on ground

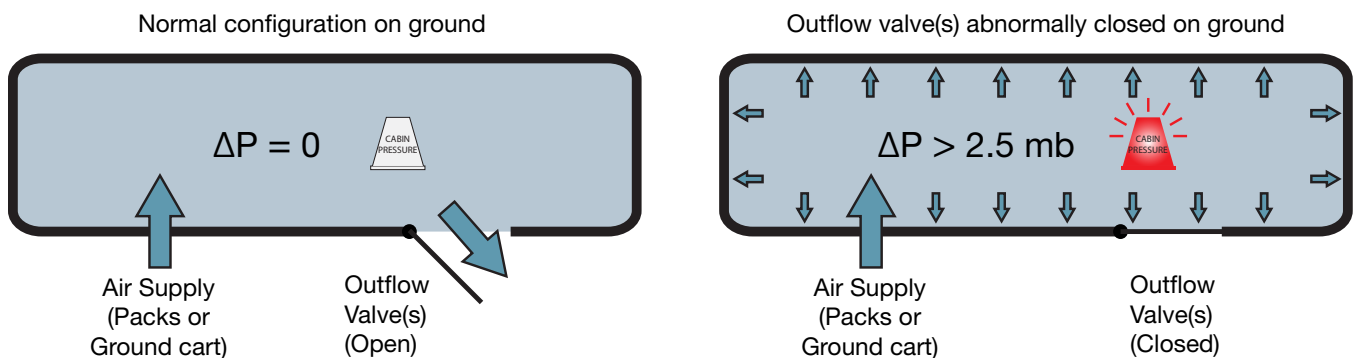

## THE RESIDUAL PRESSURE WARNING LIGHT

The Residual Pressure Warning Light (**fig.2**), part of the residual pressure warning function, warns anyone who wants to open a door if the aircraft is pressurized. This device is installed on all Airbus aircraft except for some A300, A310 and A300-600 where it was offered as an option. On these aircraft not fitted with the warning light, a caution placard located on the door reminds the operator of the risk that residual pressure may cause violent door opening.

### INFORMATION

The Residual Pressure Warning Light can be installed on cabin doors by the SB A300-52-0148, A310-52-2039, A300-52-6024.



**(fig.2)**  
Cabin door with the residual pressure warning light

# OPERATIONS

## Preventing Violent Door Opening due to Residual Cabin Pressure

### A320 AIRCRAFT FAMILY CARGO DOOR EXCEPTION

There is no residual pressure indicator on forward and aft cargo doors of A320 aircraft due to the presence of a vent door that equalizes the air pressure inside the cargo compartment with the outside when the operator opens the cargo door.

Depending on aircraft type, the Residual Pressure Warning Light is fitted on:

- Passenger doors,
- Emergency exits,
- FWD and AFT cargo-compartments doors,
- Main Deck Cargo Door on Freighter aircraft

Refer to the FCOM, CCOM and AMM for Residual Pressure Warning Light locations on your aircraft.

The Residual Pressure Warning Light flashes if the following conditions are met at the same time **(fig.3)**:

1. The slide of the door is disarmed (for passenger doors and emergency exits only)
2. Engines are off or the aircraft is on ground (depending on the aircraft type)
3. The residual cabin pressure exceeds a defined threshold

**(fig.3)**

Residual pressure warning function activation logic

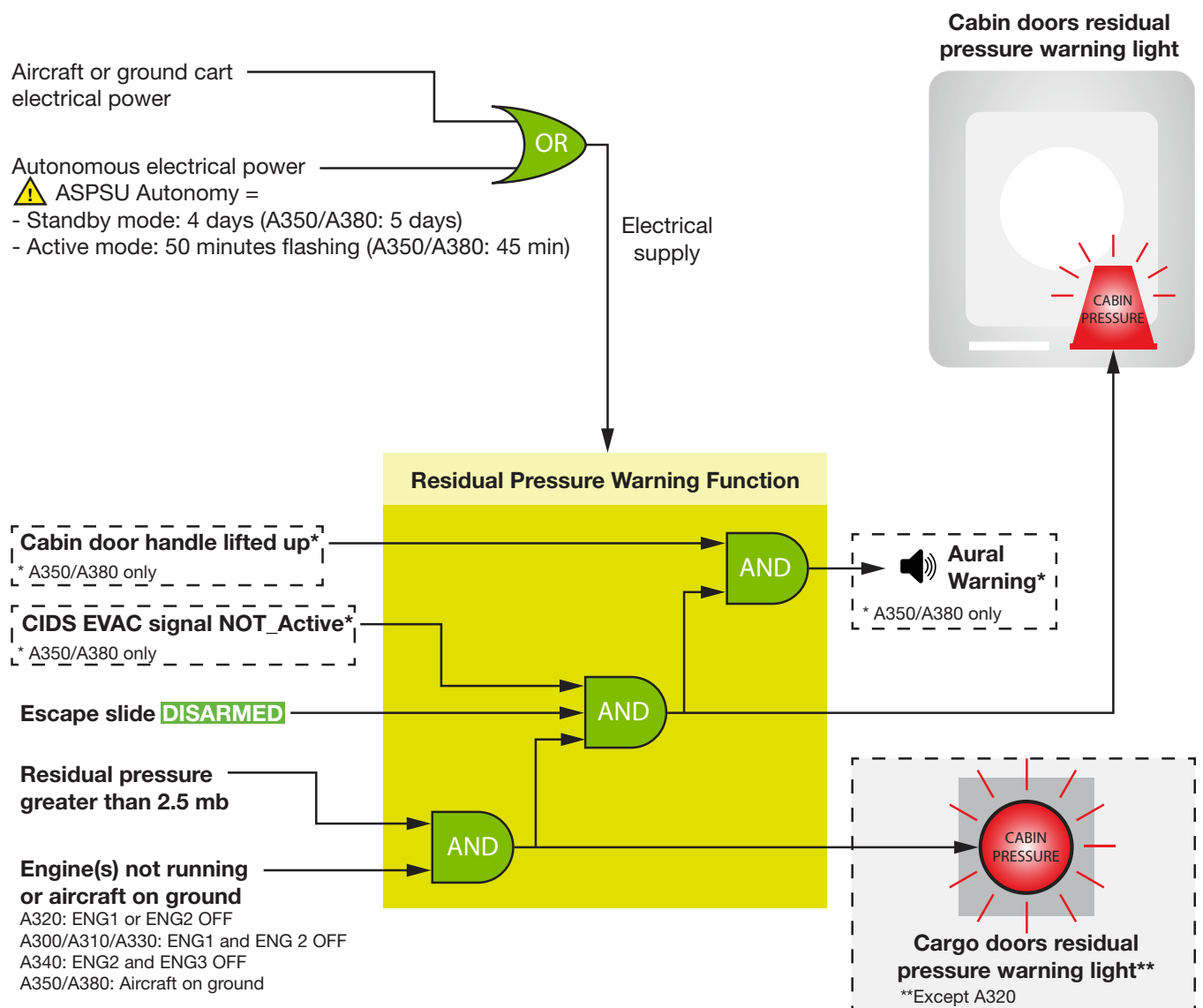

On A350 and A380 aircraft, there is an aural warning in addition to the Residual Pressure Warning Light. It will sound, together with the flashing warning light, when the 3 triggering conditions mentioned above are met and the operator begins to lift the door handle a few degrees.

## General Recommendations to avoid violent door opening

In several events reported to Airbus, an operator tried to open a door even though the warning light was flashing. Due to the overpressure, the door violently opened, causing damage to the aircraft and injury to the operator.

### Recommendations

Anyone operating an aircraft door must be trained to the associated procedures.

If the operator (flight crew, cabin crew or ground staff) observes that the Residual Pressure Warning Light is flashing, they must not attempt to open the door. If the cabin crew sees the light flashing from inside the cabin, they must immediately alert the flight crew (as per CCOM SOP). The flight crew should check the differential pressure and outflow valves position on the ECAM and take the necessary actions. Then, the cabin crew must wait for flight crew authorization to open the doors.

If the Residual Pressure Warning Light is seen flashing from the outside of an aircraft, the position of the outflow valves should be checked (**fig.4**). If outflow valves are observed closed, the ground staff should remove any connected external air source and check if an inward opening door, such as the forward avionics compartment door (**fig.5**) can be opened. If the avionics door cannot be opened, residual pressure still remains. The operator should then wait until the pressure dissipates by leakage.

## Residual Pressure Warning function specificities and limitations

### Emergency evacuation

In the case of an emergency evacuation, due to the logic of the system, the residual pressure warning light will not flash as long as the slides are **ARMED** (**fig.3**).

The CCOM “EMERGENCY PASSENGER DOOR OPERATION” procedure provides guidance to identify residual cabin pressure such as a higher resistance of the door’s control handle when lifted, or a “hissing noise” around the immediate door area. In this situation, immediate communication must be established with the flight crew.

### Limitation of the autonomous power supply of the residual pressure warning function

When there is no aircraft power supply and its main batteries are switched off, the residual pressure warning function is powered by the battery of the Autonomous Standby Power Supply Unit (ASPSU).

The ASPSU battery autonomy is (**fig.3**):

- 4 days (5 days for A380 and A350) in “stand-by” mode
- 50 minutes (45 minutes for A380 and A350) in “active” mode with the warning light flashing.

“ If the operator observes that the Residual Pressure Warning Light is flashing, they must not attempt to open the door. ”



(fig.4)

A350 Outflow valve in the open position



(fig.5)

A330 FWD avionics compartment access door (inward opening)

# OPERATIONS

## Preventing Violent Door Opening due to Residual Cabin Pressure

“ If the aircraft is unpowered for more than 4 days (5 days for A380 and A350), its residual pressure warning function is not available until the aircraft is re-energized. ”

Therefore, if the aircraft is unpowered for more than 4 days (5 days for A380 and A350), its residual pressure warning function is not available until the aircraft is re-energized. ■



### BEST PRACTICE

Check outflow valves are open before opening a cabin or a cargo door from outside to ensure there is no residual pressure in the fuselage, especially if the aircraft does not have power connected to it. The avionics compartment access door (**fig.5**) can be used to check for residual pressure and release it safely because it is an inward opening door.



### INFORMATION

On A330/A340 aircraft delivered before June 2013, an “engine running” signal is incorrectly sent to the residual pressure warning function when the aircraft is de-energized, causing the warning function to be inactive. A modification to correct this issue is available in the following Service Bulletins:

- A330-52-3094
- A340-52-4102
- A330-52-3096
- A340-52-5024

## ALERTING THE FLIGHT CREW: THE EXCESS RESIDUAL PRESSURE ECAM WARNING

In addition to the residual pressure warning function, the **CAB PR EXCES RESIDUAL PR** ECAM warning (**fig.6**) triggers if residual pressure is detected in the cabin after landing and the engines are switched off. The flight crew must follow the ECAM procedure, alert cabin crew and ground crew about the situation, and advise them not to operate the aircraft doors. ■

(fig.6)

A320 **CAB PR EXCES RESIDUAL PR** ECAM Warning



### INFORMATION

This ECAM alert is basic on all A350 and A380 aircraft and on A320/A330/A340 built since 2004. The alert can also be implemented on aircraft built prior to 2004 and on A300-600/A310 aircraft with the following Service Bulletins:

- A300-31-6135
- A310-31-2135
- A320-21-1164
- A330-21-3112
- A340-21-4121
- A340-21-5020



## NOTE

On A350 and A380 aircraft, the ECAM alert is **CAB PRESS EXCESS RESIDUAL DIFF PRESS**

This alert is not available for the A300 aircraft, however standard operating procedures at parking instruct the flight crew to check zero  $\Delta P$  prior to informing the cabin crew that aircraft doors can be opened.

## AVOIDING UNINTENTIONAL PRESSURIZATION OF THE AIRCRAFT ON GROUND

Several reported incidents of violent door opening occurred after an unintentional pressurization of the aircraft on the ground.

### Event Description

Due to winter conditions, an A320 aircraft was secured for cold soak. As per procedure, the outflow valve was closed using the DITCHING pushbutton. The next day, a ground cart was connected to the aircraft for pre-conditioning while the aircraft doors and the outflow valve were still closed. This resulted in a cabin pressure build-up. An operator did not rely on the residual pressure warning light flashing and tried to open a passenger door. The door violently opened and the operator was injured.

### Recommendations

When connecting a ground cart to the LP or HP ground air connectors, the maintenance personnel must ensure that the outflow valves are open and stay open, or one or more passenger doors are open and stay open, or the forward avionics compartment access door is open and stays open. ■

“ When connecting a ground cart to the LP or HP ground air connectors, the maintenance personnel must ensure that the outflow valves are open and stay open, or one or more passenger doors are open and stay open, or the forward avionics compartment access door is open and stays open. ”



## INFORMATION

Improved warning placards (**fig. 7**) with additional recommendations for ground personnel are installed on the LP/HP ground connection area or maintenance doors of A320 family aircraft delivered since March 2015, on A330/A340 aircraft delivered since February 2014 and A380 aircraft delivered since October 2010 and on all A350 aircraft. The placards can be installed on the remaining aircraft by the following Service Bulletins:

- SB A320-11-1097
- SB A330-21-3171
- SB A340-21-4158
- SB A340-21-5050
- SB A380-21-8040

## OPERATIONS

### Preventing Violent Door Opening due to Residual Cabin Pressure

**(fig.7)**

Example of an improved placard on A330

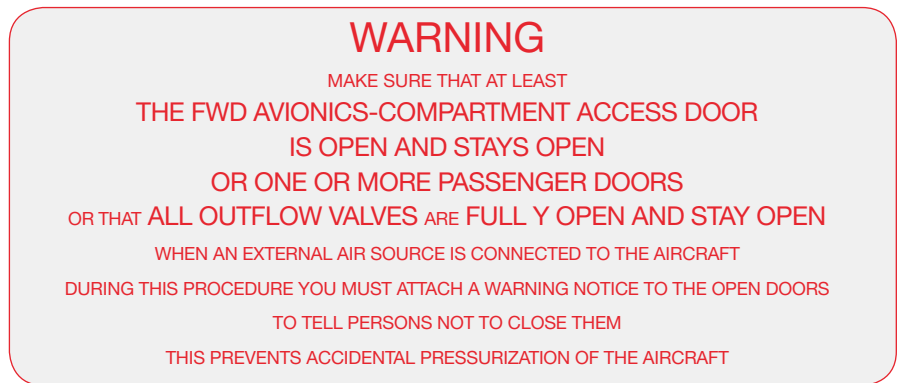

On A310 aircraft delivered after May 1994 and A300-600 aircraft delivered after December 1994, a modification introduces a mechanical fool-proof device which prevents connection of the ground supply to the aircraft LP ground connector until the service door 136AR has been removed. This avoids build-up of cabin pressure and subsequent risks of violent door opening when a LP ground source is connected to the aircraft. On aircraft not fitted with this modification from production this can be embodied by application of recommended SB A300-21-0119, A310-21-2045 or A300-21-6029.

## RESIDUAL CABIN PRESSURE FOLLOWING THE USE OF THE MANUAL PRESSURE CONTROL MODE

If all cabin pressure controllers fail, the ECAM procedure requires the flight crew to manually control the cabin pressure.

Incorrect manual pressure control by the flight crew following landing can lead to the outflow valves to remain closed when the aircraft taxis to the gate.

On A320/A330/A340 aircraft, Airbus developed a solution to this issue: the Residual Pressure Control Unit (RPCU). The RPCU automatically opens the outflow valves on the ground when the aircraft is operated in manual pressure control mode. ■



### INFORMATION

The RPCU is installed in production on A320 family aircraft delivered after August 2005 and on A330/A340 aircraft delivered after October 2005.

The RPCU can be installed on A320 family aircraft delivered before August 2005 through the SB A320-21-1154.

On A380 and A350 aircraft, the RPCU functionality is integrated into the Cabin Pressure Controllers that prevent closure of the outflow valves when residual cabin pressure is detected on ground.

The RPCU is not available on A300/A300-600/A310 aircraft.



**CONTRIBUTORS:****David HUART**

Cabin Pressure Control Expert  
Engineering

**Thorsten KNIJNENBURG**

RPWS Expert  
Engineering

**Mohammed ALAHYANE**

Product Leader  
Emergency Equipment  
Customer Engineering Support

**Jean-Paul VIEU**

Cabin Operations Engineer  
Cabin Safety Enhancement  
Flight Operations and  
Training Support

**Ian GOODWIN**

Director Product  
Safety Enhancement  
Product Safety

**With thanks to:**

**Didier GENDRE,  
Dominique GRISEL,  
Cyril MONTROYA,  
Benjamin CALVET,  
and Aurélie WOZNIAK**

Opening an aircraft door is done thousands of times a day without incident, however particular care should be taken to do this task. Any personnel opening aircraft doors must be trained to the associated procedures.

Relying on the Residual Pressure Warning Light is the key to prevent violent door opening events due to residual cabin pressure: if the Residual Pressure Warning Light is flashing, the door **MUST NOT** be opened. If the light is seen flashing from the inside, the cabin crew must contact the flight crew who will take the necessary actions to remove the residual pressure. Good communication between the flight crew and the cabin crew is essential.

Checking outflow valves are open is a fast way to confirm that an aircraft is not pressurized. If an inward avionics compartment door is difficult to open, this is another indication that the aircraft is pressurized.

It is also important to remember that the residual pressure warning function is only available for 4 days (5 days on A350/A380) when the electrical power is removed from an aircraft.

To avoid unintentional pressurization of an aircraft when connecting a ground air supply, the maintenance personnel must ensure:

- The outflow valves are open and stay open, or
- One aircraft passenger door is open and stays open, or
- The forward avionics compartment door is open and stays open.



# Lessons Learned About the Teach-In Function

Emergency lights must illuminate when required for aircraft evacuations. If maintenance is not performed correctly, this can compromise the availability of the emergency lights.

If all of the Emergency lights do not illuminate when they are most needed, especially if the cabin is dark or filling with smoke, the most efficient evacuation path to exit the aircraft may not be clearly visible when it is most critical. Passengers and crew may also need to see the cabin emergency lights to help them regain their orientation or situational awareness in an emergency.

Correctly setting-up the Emergency Lighting System during maintenance and performing regular checks to detect any defects are key to ensuring safe cabin operations. It is important to be aware of the correct use for the “Teach-In” function of the Emergency Power Supply Units (EPSU) and avoid system test or fault monitoring set-up errors. “Teach-In” is a configuration tool, but is not designed for troubleshooting.

### **No Lights May Mean NO-GO**

When critical cabin emergency lights are not illuminating, it may lead to a NO-GO condition. If these faults remain undetected due to incorrect system monitoring set-up, some of cabin emergency lights may not illuminate when required. There is a risk that the aircraft could be dispatched with a NO-GO condition. If it is the case that faulty lights or components are hidden from the system test or monitoring, then only a complete visual check will identify all of the emergency lights which are not illuminating. It is important for cabin crew to perform a thorough visual inspection of all emergency lights, as described by the Cabin Crew Operating Manual's Ground Check, as well as visual checks by maintenance personnel during troubleshooting.

## **EPSU SYSTEM TEST AND TEACH-IN**

### **TWO DIFFERENT FUNCTIONS**

#### **System Test Function**

The Emergency Light System Test is triggered either centrally from Multifunction Control Display Unit (MCDU on A320/A330/A340 family aircraft), Onboard Maintenance Terminal (OMT for A350XWB/A380) or locally on the EPSU itself (**fig. 1**). The EPSU starts a test routine that includes a self-test and a test of all the electrical components connected to it, including its battery and the emergency lights.

This test is a measurement of the actual current on each output compared with a reference value that is stored in the memory of the EPSU. If the tests detects differences in these values outside of pre-defined limits, this will generate a fault indication. In the case of a short circuit, an EPSU internal fuse will disconnect the output. The EPSU on A320/A330/A340 family aircraft is a thermal fuse, which requires removal of the unit to replace the fuse in a repair center. An EPSU installed on A350XWB and A380 aircraft has a resettable solid state fuse.

“ Teach-In is a configuration tool, but is not designed for trouble-shooting. ”

“ In the case of a short circuit, an EPSU internal fuse will disconnect the output. ”

# OPERATIONS

## Lessons Learned About the Teach-In Function

**(fig.1)**

Emergency Light System Test is triggered centrally from the MCDU/OMT or locally on the EPSU TEST P/B (pushbutton).

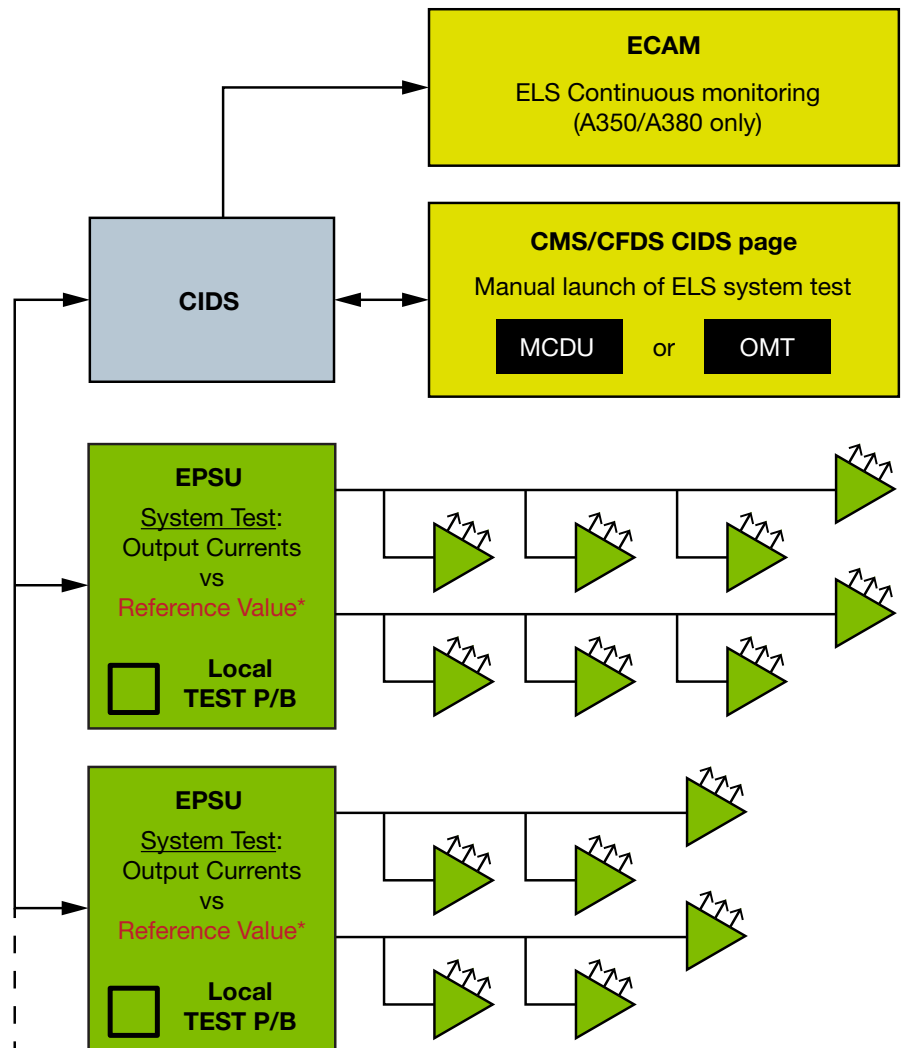

\* Reference Value measured at EPSU setup using the Teach-in function

“ Teach-In starts automatically when an EPSU is connected to an aircraft which is powered. ”

### Teach-In Function

When an EPSU is installed on the aircraft it must first learn the correct reference values. This is managed by the EPSU “Teach-In” procedure, which shall only be performed only after the assembly of the system is complete and a visual inspection to first verify the proper function of all emergency lights.

During the Teach-In procedure, all outputs are operated for a short time to capture their specific current. This value is stored in the EPSU as the reference value. It is used for comparison with the actual electrical loads, which are measured at the outputs of the EPSU during the System Test.

Teach-In starts automatically on A320/A330/A340 family aircraft, and for A380 aircraft, when an EPSU is connected to an aircraft which is powered, or when a battery pack is reconnected to the EPSU **(fig.2)**. On A350XWB aircraft, the Teach In is manually triggered by pressing the test button on the EPSU for more than 5 seconds.

### Why is there a Teach-In function on the EPSU?

Teach-In function on electronic units like the EPSU allows for common part numbers to be used across a fleet of aircraft with different models, and with their

various cabin configurations. Aircraft cabins are customized by each airline. The Emergency Lighting System must therefore be configurable to operate correctly in a customized cabin layout. It also allows for common EPSU part numbers to be used with both the older emergency light systems fitted with traditional light bulbs, and the newer systems that have LED lights requiring much less electrical current. ■

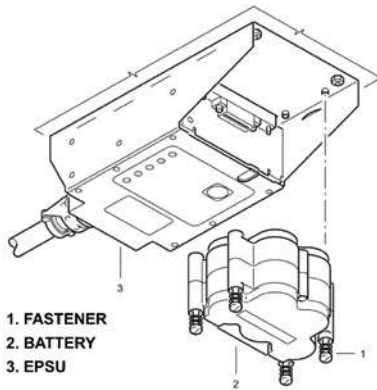

**(fig.2)**

EPSU with battery removed – The “Teach-In” function will activate when 28V DC power is available on the aircraft and the battery is reinstalled.

## USING TEACH-IN FUNCTION

### The Right Way and the Wrong Way

#### The Right Way to Use “Teach-In”

After any Emergency Light System configuration change, such as a cabin layout modification or replacing a system’s traditional “bulb” lights with modern LED lights, the Teach-In procedure is necessary to determine the correct reference value to store in the EPSU memory for the system test. Before starting the Teach-In, a visual inspection to verify that all lights are operative is required. The Teach-In procedure should only be done strictly in accordance with the applicable AMM/MP.

#### The Wrong Way to Use “Teach-In”

The Teach-In function is not to be used during troubleshooting of the Emergency Light System and the EPSU. Teach-In function is not a system reset function. There is NO Emergency Light fault RESET function on the EPSU.

### Consequences of Using Teach-In to Clear Faults

Initiating the EPSU Teach-In procedure in an Emergency Light System that has inoperative lights or defects present has three main consequences. To avoid these consequences, **DO NOT** clear Emergency Light System faults, with their associated ECAM message, by either disconnecting the affected EPSU’s battery, swapping EPSU positions or replacing an EPSU before first identifying and rectifying the root cause of the fault message.

#### Hidden Defects

After the Teach-In procedure is completed on the EPSU, it will no longer detect the defect is present and a fault message will not be displayed. The defect is effectively hidden from the system test because the EPSU has stored a new reference value that was measured with the defective component in the system **(fig.3)**.

“ Teach-In function is not a system reset function. ”

“ To avoid these consequences, DO NOT clear Emergency Light System faults by disconnecting the EPSU battery, swapping positions or replacing the EPSU. ”

**(fig.3)**

Emergency Light System Fault – DO NOT USE TEACH-IN FUNCTION TO CLEAR A FAULT.

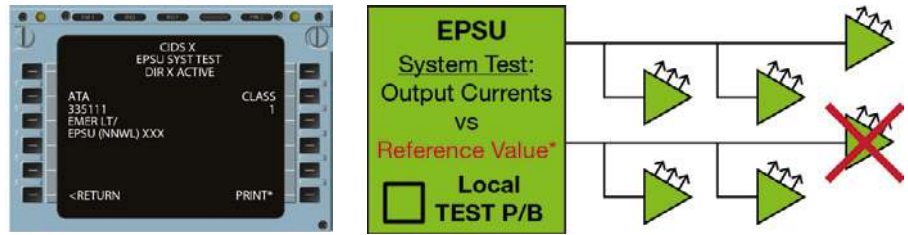

**DO NOT USE THE TEACH-IN FUNCTION TO CLEAR A FAULT!**  
THIS WILL HIDE THE FAULT FROM THE NEXT TEST AND CAUSE NEW FAULT MESSAGES IF THE DEFECT IS RECTIFIED

### False Fault Message

If the defect is later detected during a visual inspection and it is then repaired, the EPSU test will display a fault message even though there is no longer a defect present in the system. This is because there will be a difference between the measured electrical loads and the false reference value captured during the Teach-In when the defect was still present. This could generate confusion for maintenance personnel and it may lead to lengthy troubleshooting with the risk of operational delays.

### Repeated Fuse Tripping

If the defect is a short circuit on the output of the EPSU on A320/A330/A340 family aircraft, then the EPSU must be replaced. If the cause of the short circuit is not repaired, this will immediately damage the fuse of the replacement unit EPSU. This fuse is only resettable on EPSU used for A350XWB and A380 aircraft. The fuse will repeatedly trip to disconnect the current at the EPSU output and this causes the fault to reappear until the defect is rectified. ■

## DETECTING FAULTS IN THE EMERGENCY LIGHT SYSTEM

An Emergency Light System fault message only indicates a Fault Isolation Number (or FIN) for the affected EPSU, but that EPSU is usually not the direct cause of the defect. It is more likely that a component or light connected to that EPSU is defective and is the reason for the fault message.

There are 3 ways to identify faults or lights not illuminating in the Emergency Lighting System:

### 1. Visual Inspection

A thorough visual check of all of the emergency lights by Cabin Crew or Maintenance Personnel should find any lights that are not illuminating. These should be reported by Cabin Crew, as per the CCOM Ground Check, or recorded by maintenance for troubleshooting or replacement in accordance with TSM & AMM/MP 33-51-00.

## 2. System BITE Monitoring

On A350XWB and A380 aircraft, a continuous system monitoring compares the electrical loads at the outputs of the EPSU with a stored reference value during its previous Teach-In process. If the measured electrical load deviates from the stored reference value, a maintenance message (or “dispatch message” for A350XWB aircraft), will appear to alert Flight crew and maintenance of a defect in the aircraft’s Emergency Lighting System **(fig.4)**. In this case, refer to the Troubleshooting procedure in TSM & AMM/MP 33-51-00 and DO NOT use the EPSU Teach-In process to clear the fault.

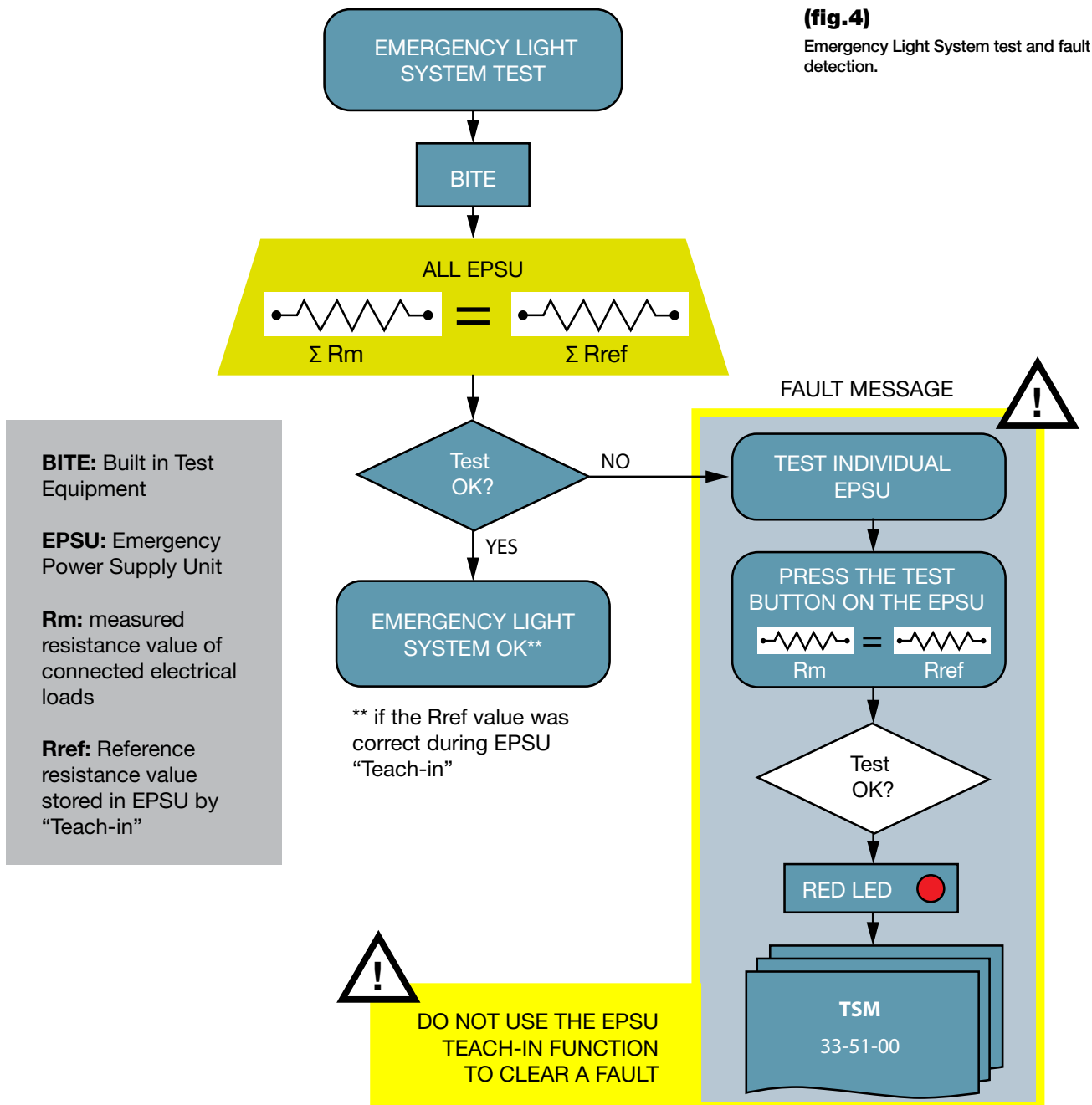

### 3. System Test

Emergency Light System test is carried out by maintenance personnel in accordance with AMM/MP 33-51-00. This will manually launch the system monitoring described above (for System BITE monitoring). The LED indicator on the EPSU will advise what components to check to find the cause of the fault.

The Emergency Lighting System Test can be performed locally on each EPSU by pressing the TEST button. Caution: On A350XWB pressing the test button for more than 5 seconds launches the Teach-In function for that EPSU. ■

#### CONTRIBUTORS:

##### **Pierre MONTANIER**

A320 Family Product Leader  
Cabin Electronics and Seats  
Airbus Customer Engineering  
Support

##### **Carsten KOHLMEIER- BECKMANN**

Senior Expert Lighting Systems  
Engineering Cabin & Cargo

Teach-In function on the EPSU is not a reset function and it shall not be used to troubleshoot a fault message related to the Emergency Light System. To avoid the risk of dispatching the aircraft in a NO-GO condition, DO NOT use the Teach-In function to clear EPSU failure messages coming from a system test or monitoring. Caution also needs to be taken to ensure that the Teach-In function is not inadvertently activated. This could cause the EPSU to store an incorrect electrical load reference value, and a wrong value may hide any defective emergency lights during the system test.

A pre-requisite prior to activating the Teach-In function is to first check that all of the emergency lights connected to an EPSU illuminate. By correctly configuring the Emergency Lighting System, conducting regular visual inspections and performing scheduled system tests to find and fix defects, it will ensure that all of the aircraft's emergency lights are operational when they are most needed – for lighting the path to the nearest and safest exit for passengers and crew during an emergency cabin evacuation.



# D10X

---

Air Transport Safety  
Destination 10X together

[ats.destination10x@airbus.com](mailto:ats.destination10x@airbus.com)

App now available  
for all of our customers



# ARTICLES PUBLISHED IN PREVIOUS 'SAFETY FIRST' ISSUES

Available in the Safety first app and website:  
[safetyfirst.airbus.com](http://safetyfirst.airbus.com)

## Issue 26

### July 2018

- Look out for Ice Ridges on the Lower Nose Fuselage
- High Load Event Reporting
- Using Aircraft as a Sensor on Contaminated Runways
- Thrust Reverser Deployment in Flight

## Issue 25

### January 2018

- Are You Properly Seated?
- A Recall of the Correct Use of the MEL
- Protecting Aircraft and Passengers from Cargo Fire

## Issue 24

### July 2017

- Control your Speed... During Descent, Approach and Landing
- Troubleshooting Airframe Vibrations
- Preventing Falls from Height
- Progress to Pinpoint an Aircraft's Position

## Issue 23

### January 2017

- Safely Flying Non-Precision Instrument Approaches
- Introduction to the Soft Go-Around Function
- Preparing Flight Crews to Face Unexpected Events
- Safety, Our Shared Destination

## Issue 22

### July 2016

- Pitot Probe Performance Covered On the Ground
- 180° turns on runway
- Optimum use of weather radar

## Issue 21

### January 2016

- Control your speed... in cruise
- Lithium batteries: safe to fly?
- Wake vortices
- A320 Family Aircraft configuration

## Issue 20

### July 2015

- Control your speed... during climb
- Lateral runway excursions upon landing
- Fuel monitoring on A320 Family aircraft
- High-altitude manual flying

## Issue 19

### January 2015

- Tidy cockpit for safe flight
- Landing on contaminated runways
- Understanding weight & balance
- Wind shear: an invisible enemy to pilots?

## Issue 18

### July 2014

- Control your speed... at take-off
- Safe operations with composite aircraft
- Learning from the evidence
- A320 Family cargo Containers/ pallets movement
- Parts Departing from Aircraft (PDA)

## Issue 17

### January 2014

- Airbus Brake Testing
- Hard Landing, a Case Study for Crews and Maintenance Personnel
- Aircraft Protection during Washing and Painting
- Flight Data Analysis (FDA), a Predictive Tool for Safety Management System (SMS)
- Flying a Go-Around, Managing Energy

## Issue 16

### July 2013

- **Performance Based Navigation:** RNP and RNP AR Approaches
- **Atlantic Airways:** Introduction of RNP AR 0.1 Operations
- Flight Crews and De-Icing Personnel – Working together in Temporary Teamwork for safe Skies
- Low Speed Rejected Take-Off upon Engine Failure
- Late Changes before Departure

## Issue 15

### January 2013

- The Golden Rules for Pilots moving from PNF to PM
- Airbus Crosswind Development and Certification
- The SMOKE/FUMES/AVNCS SMOKE Procedure
- Post-Maintenance Foreign Objects Damage (FOD) Prevention
- **Corrosion:** A Potential Safety Issue

## Issue 14

### July 2012

- Thrust Reverser Selection means Full-Stop
- Transient Loss of Communication due to Jammed Push-To-Talk A320 and A330/A340 Families
- **A380:** Development of the Flight Controls - Part 2
- Preventing Fan Cowl Door Loss
- Do not forget that you are not alone in Maintenance

## Issue 13

### January 2012

- A320 Family / A330 Prevention and Handling of Dual Bleed Loss
- The Fuel Penalty Factor
- The Airbus TCAS Alert Prevention (TCAP)
- **A380:** Development of the Flight Controls - Part 1
- Facing the Reality of everyday Maintenance Operations

**Issue 12****July 2011**

- Airbus New Operational Landing Distances
- The Go Around Procedure
- The Circling Approach
- VMU Tests on A380
- Automatic Landings in Daily Operation

**Issue 11****January 2011**

- What is Stall? How a Pilot Should React in Front of a Stall Situation
- Minimum Control Speed Tests on A380
- Radio Altimeter Erroneous Values
- Automatic NAV Engagement at Go Around

**Issue 10****August 2010**

- **A380:** Flutter Tests
- **Operational Landing Distances:** A New Standard for In-flight Landing Distance Assessment
- Go Around Handling
- **A320:** Landing Gear Downlock
- Situation Awareness and Decision Making

**Issue 9****February 2010**

- **A320 Family:** Evolution of Ground Spoiler Logic
- Incorrect Pitch Trim Setting at Take-Off
- Technical Flight Familiarization
- Oxygen Safety

**Issue 8****July 2009**

- The Runway Overrun Prevention System
- The Take-Off Securing Function
- **Computer Mixability:** An Important Function
- Fuel Spills During Refueling Operations

**Issue 7****February 2009**

- **Airbus AP/FD TCAS Mode:** A New Step Towards Safety Improvement
- Braking System Cross Connections
- Upset Recovery Training Aid, Revision 2
- Fuel Pumps Left in OFF Position
- **A320:** Avoiding Dual Bleed Loss

**Issue 6****July 2008**

- **A320:** Runway Overrun
- FCTL Check after EFCS Reset on Ground
- **A320:** Possible Consequence of VMO/MMO Exceedance
- **A320:** Prevention of Tailstrikes
- Low Fuel Situation Awareness
- Rudder Pedal Jam
- Why do Certain AMM Tasks Require Equipment Resets?
- Slide/raft Improvement
- Cabin Attendant Falling through the Avionics Bay Access Panel in Cockpit

**Issue 5****December 2007**

- New CFIT Event During Non Precision Approach
- **A320:** Tail Strike at Take-Off?
- Unreliable Speed
- Compliance to Operational Procedures
- The Future Air Navigation System FANS B

**Issue 4****June 2007**

- Operations Engineering Bulletin Reminder Function
- Avoiding High Speed Rejected Take-Offs Due to EGT Limit Exceedance
- Do you Know your ATC/TCAS Panel?
- Managing Hailstorms
- Introducing the Maintenance Briefing Notes
- **A320:** Dual hydraulic Loss
- Terrain Awareness and Warning Systems Operations Based on GPS Data

**Issue 3****December 2006**

- Dual Side Stick Inputs
- Trimmable Horizontal Stabilizer Damage
- Pitot Probes Obstruction on Ground
- **A340:** Thrust Reverser Unlocked
- Residual Cabin Pressure
- Cabin Operations Briefing Notes
- **Hypoxia:** An Invisible Enemy

**Issue 2****September 2005**

- Tailpipe or Engine Fire
- Managing Severe Turbulence
- Airbus Pilot Transition (ATP)
- Runway Excursions at Take-Off

**Issue 1****January 2005**

- Go Arounds in Addis-Ababa due to VOR Reception Problems
- The Importance of the Pre-flight Flight Control Check
- **A320:** In-flight Thrust Reverser Deployment
- Airbus Flight Safety Manager Handbook
- Flight Operations Briefing Notes

